

Typical schemes of laying the gas pipeline in the trench

Without crossing communications
(trench depth max 2300 mm)

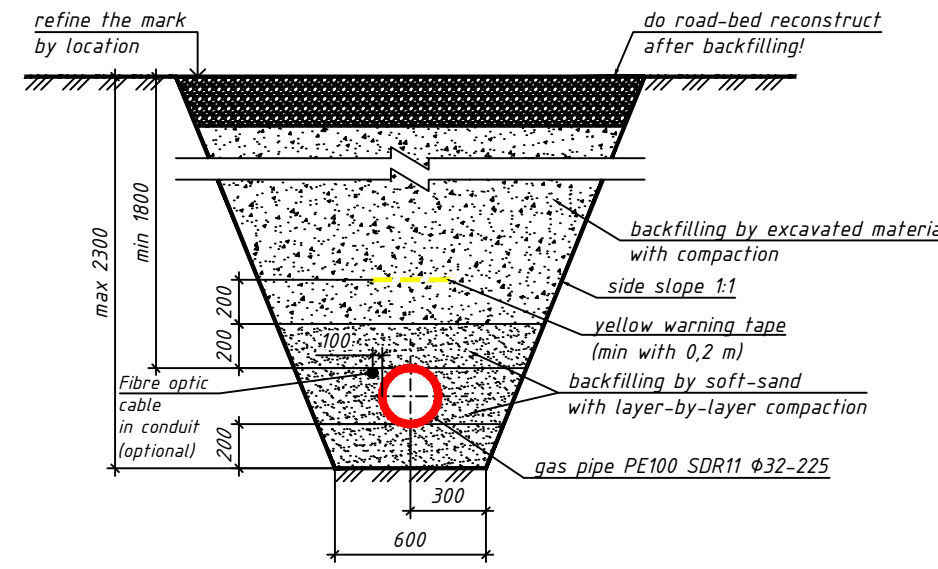

Without crossing communications
(trench depth max 4000 mm)

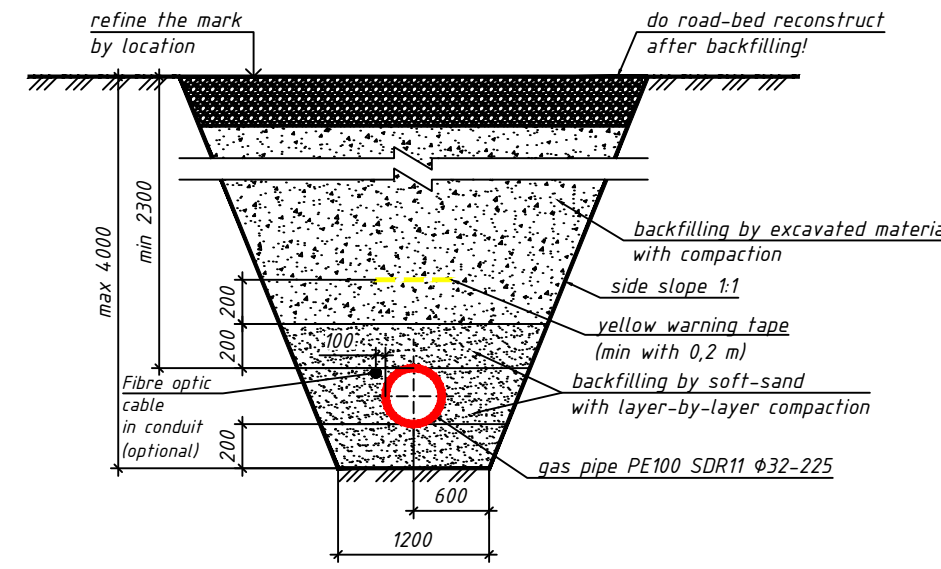

Gas pipe crossing water pipe
under it

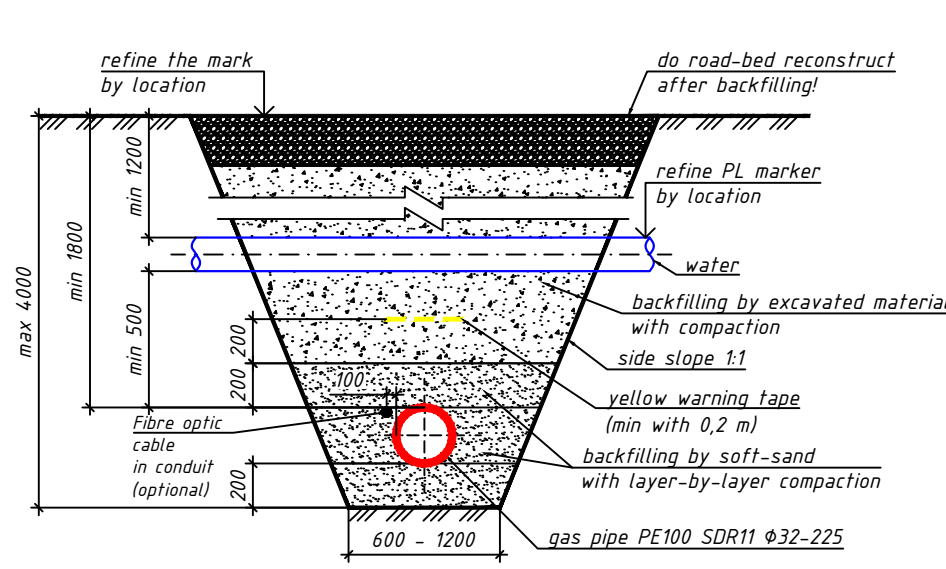

Gas pipe crossing drainage pipe
under it

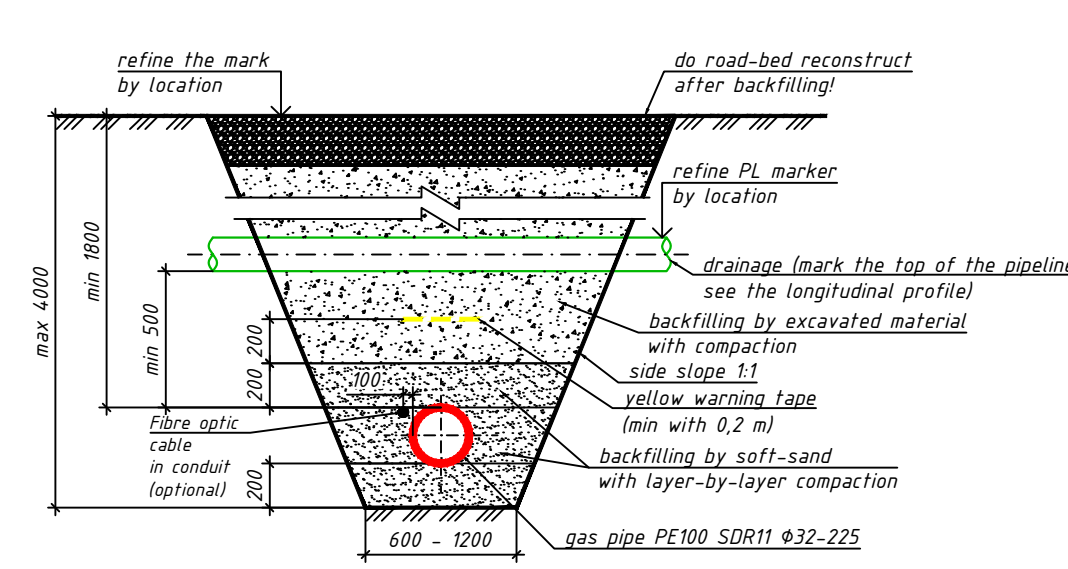

Gas pipe crossing sewage pipe
under it

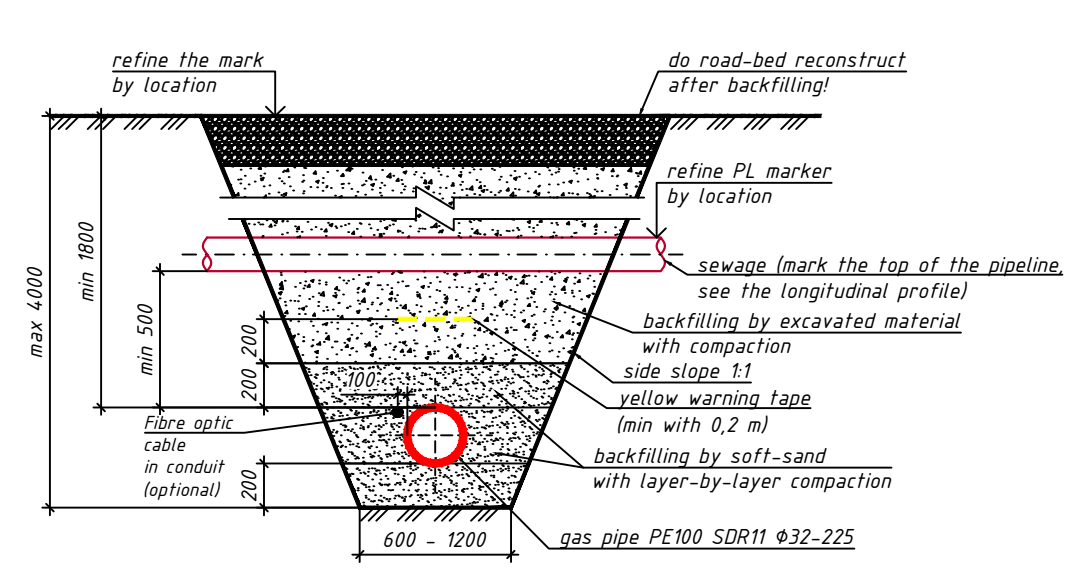

Gas pipe crossing irrigation pipe
under it

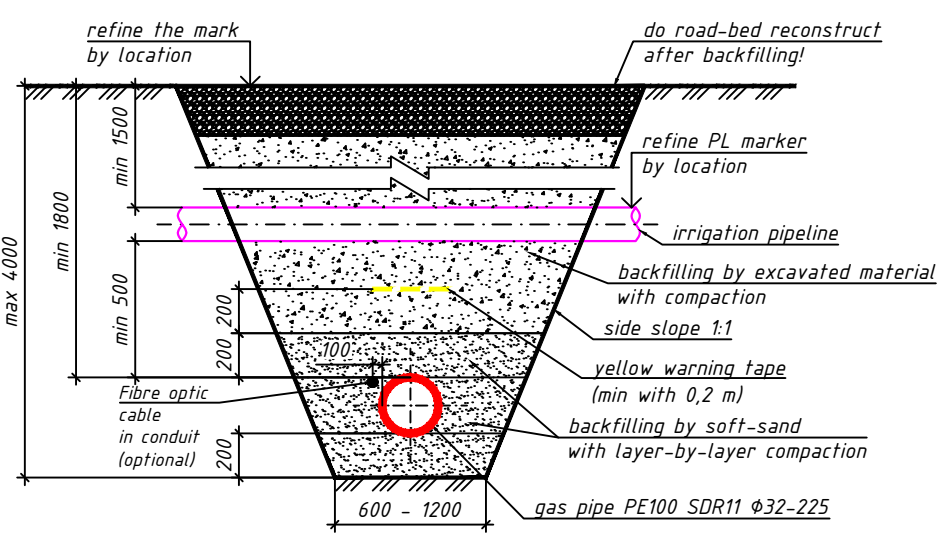

Gas pipe crossing sewage,
drainage, irrigation or water
pipes

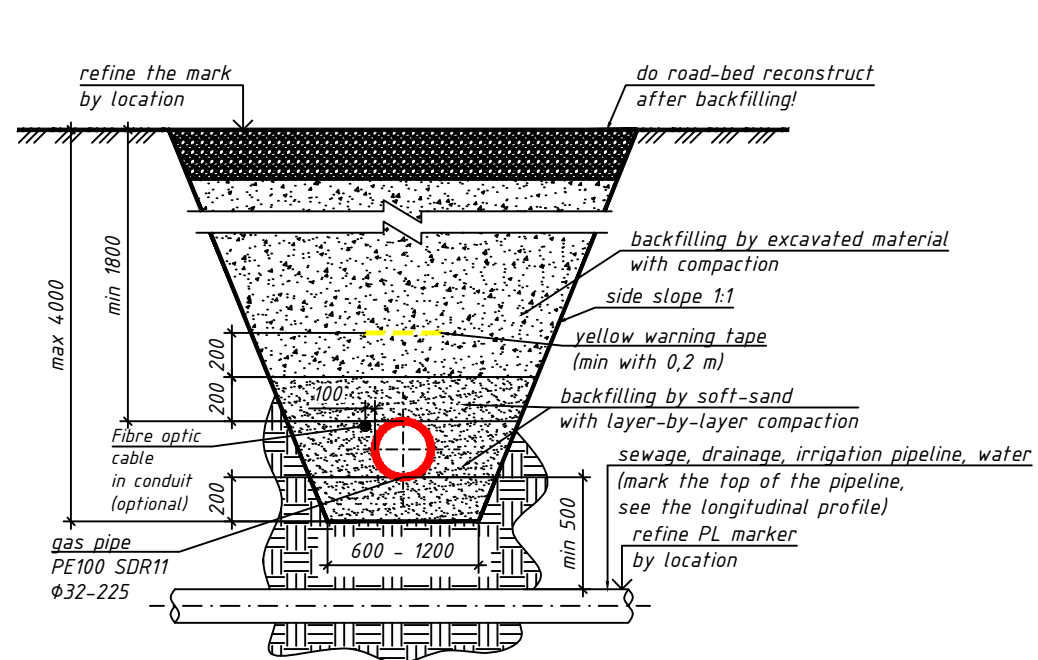

Gas pipe crossing electrical light
that goes along the sidewalk

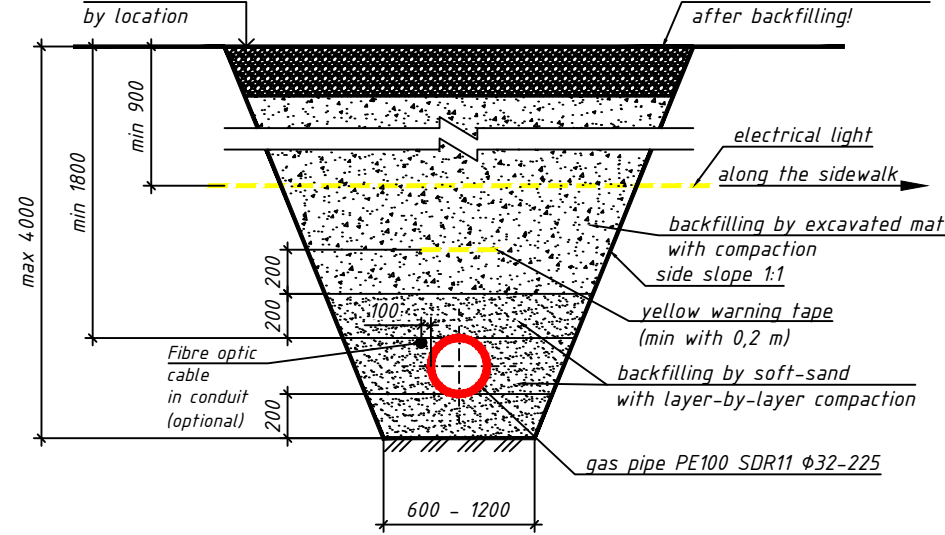

Gas pipe crossing communication lines
that goes along the sidewalk

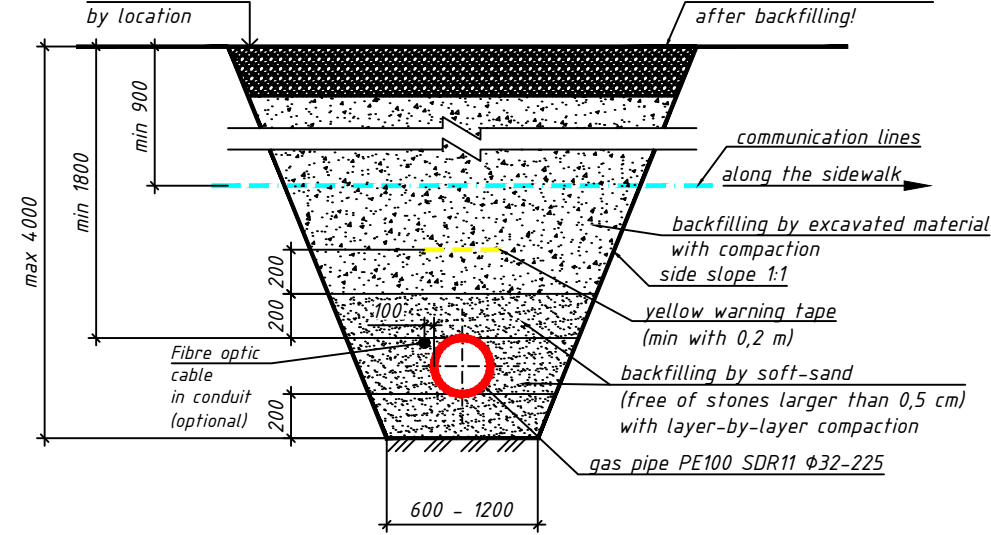

Gas pipe crossing electrical line
that goes along the sidewalk

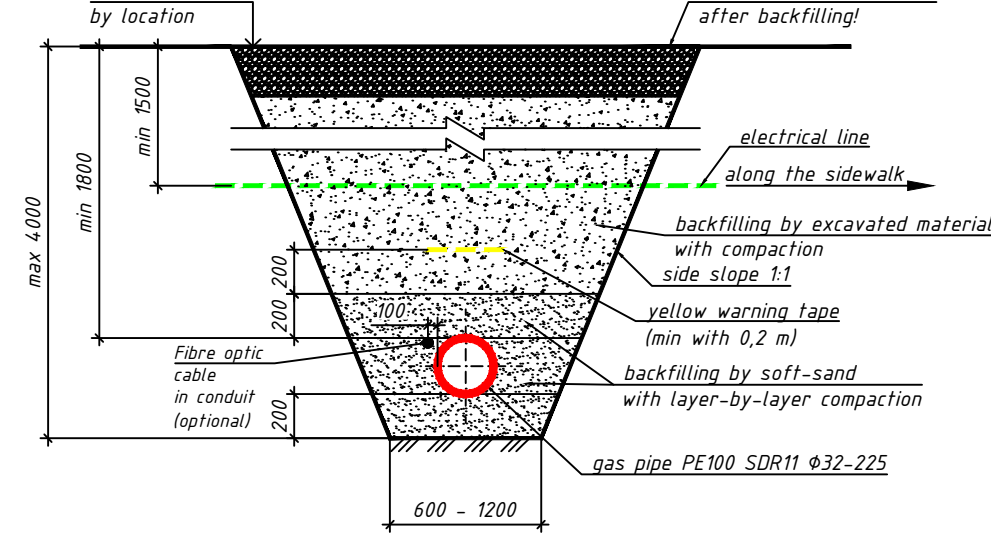

Gas pipe crossing electrical light
that goes along the road

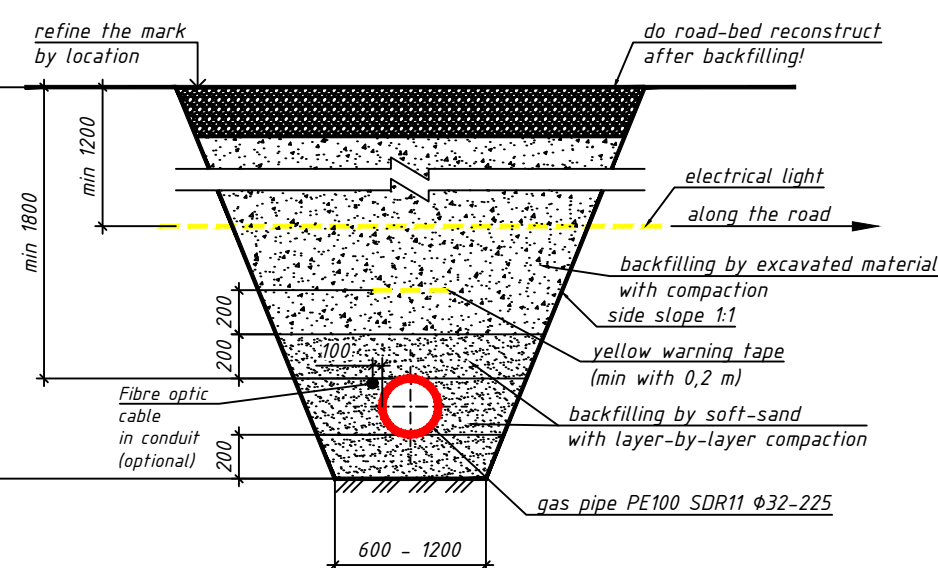

Gas pipe crossing communication lines
that goes along the road

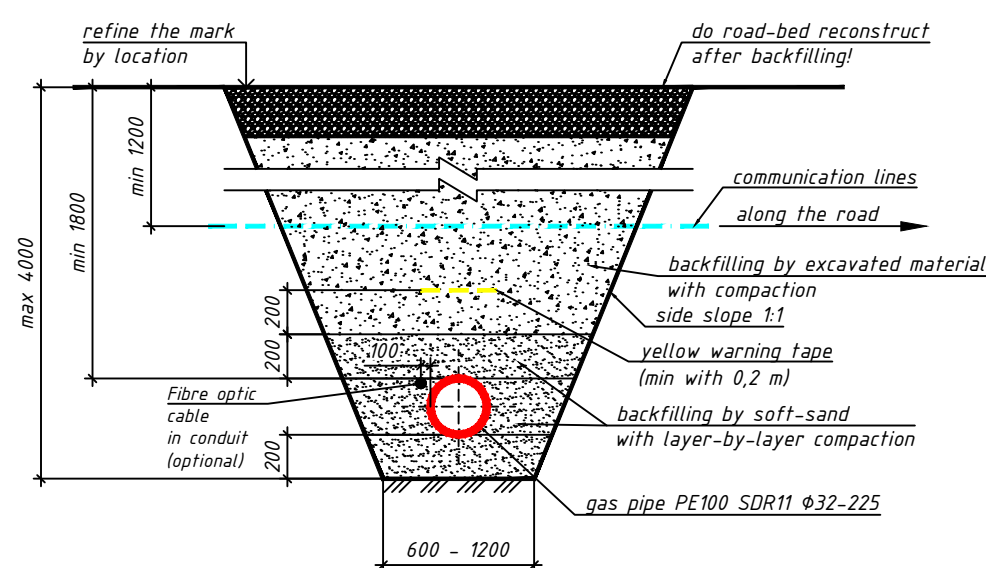

Gas pipe crossing electrical line
that goes along the road

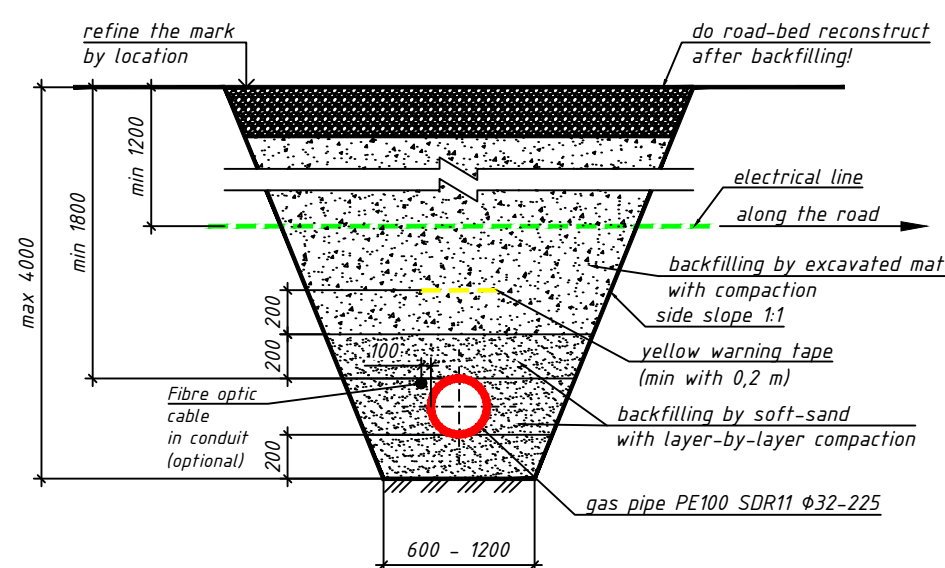

Trench with vertical slopes and
prefabricated panels

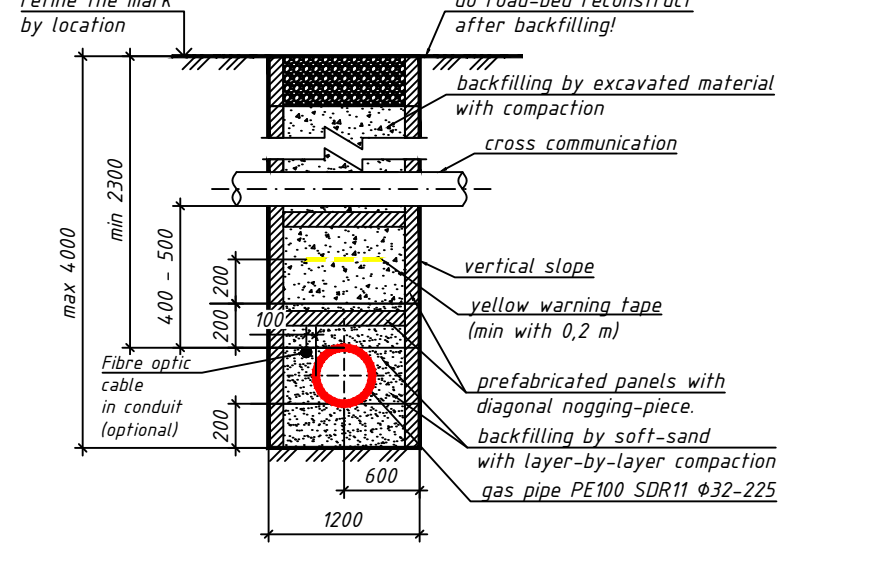

Covering control tube

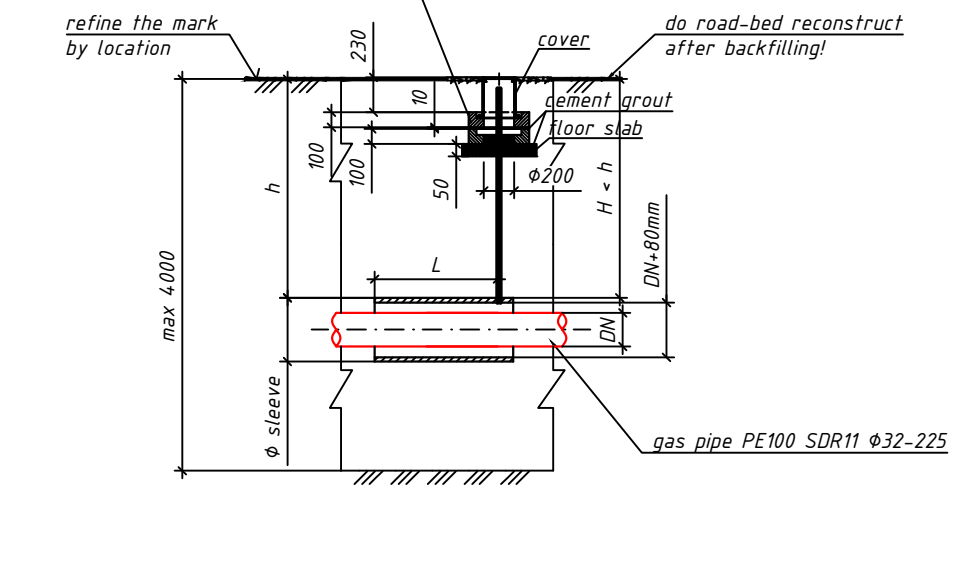

04	-	-	-	-
03	-	-	-	-
02	-	-	-	-
01	-	-	-	-
00	-	-	-	-
Rev No.	Description	Signature	Date	
-	<input type="checkbox"/> For Comments <input checked="" type="checkbox"/> For Approval <input type="checkbox"/> For Tender <input type="checkbox"/> For Execution <input type="checkbox"/> As Made			

Coordinator

Company
NEGEV NATURAL GAS LTD
7 Masada St. Besser Building 4 Bnei Brak, POB 47, 5126112 Tel:03-5228508
Fax:03-5662521 Email:office@negevgas.co.il

Document Title:
NATURAL GAS DISTRIBUTION NETWORK
Ma'alot Ha Nahal Neighborhood
Typical schemes of laying the gas pipeline in the trench

External No. (for use by contractor/designer)	Document No.	Rev. #				
CNT-CSC-DSG-0001	CNT-CSC-DSG-0001	00				
Project/Ref. No.	Region/Area					
CNT - Netivot - Ma'alot Ha Nahal	Netivot					
Order No.	Scale:					
		1:100				
Name:	Designed:	Constructor:	Inspector:	Drawn:	Approved:	Approved:
Sign:	T.Gotsulenko			T.Gotsulenko	Y.Leviel	O.Golberg
Date:	18/02/2020			18/02/2020	18/02/2020	18/02/2020